

Features

1. Current transfer ratio
(CTR:MIN.50% at $I_F=5mA$ $V_{ce}=5V$)
2. High isolation voltage between input and output
(Viso:5000Vrms).
3. Compact dual-in-line package.
4. Available package : DIP/ SMD/ H. (For Package Dimension please refer to page 82)

Applications

1. Registers, copiers, automatic vending machines.
2. System appliances, measuring instruments.
3. Computer terminals, programmable controllers.
4. Communications, telephone, etc.
5. Electric home appliances, such as oil fan heaters, Microwave oven, Washer, Refrigerator, Air conditioner, etc.
6. Medical instruments, physical and chemical equipment.
7. Signal transmission between circuits of different potentials and impedances.
8. Facsimile equipment, Audio, Video.
9. Switching power supply, Laser beam printer.

Outside Dimension : Unit (mm)

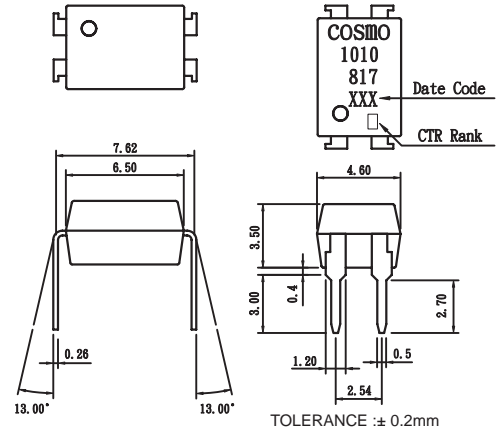

Schematic : Top View

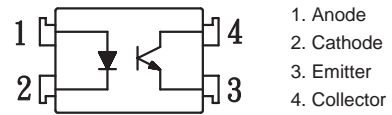

1. Anode
2. Cathode
3. Emitter
4. Collector

Absolute Maximum Ratings

($T_a=25^\circ C$)

Parameter	Symbol	Rating	Unit
Input	Forward current	I_F	50
	Peak forward current	I_{FM}	1
	Reverse voltage	V_R	6
	Power dissipation	P_D	70
Output	Collector-emitter voltage	V_{CEO}	60
	Emitter-collector voltage	V_{ECO}	6
	Collector current	I_C	50
	Collector power dissipation	P_C	150
Total power dissipation	P_{tot}	200	
Isolation voltage 1 minute	Viso	5000	
Operating temperature	T_{opr}	-30 to +100	
Storage temperature	T_{stg}	-55 to +125	
Soldering temperature 10 second	T_{sol}	260	

Electro-optical Characteristics

($T_a=25^\circ C$)

Parameter	Symbol	Conditions	MIN.	TYP.	MAX.	Unit
Input	Forward voltage	$I_F = 20mA$	—	1.2	1.4	V
	Peak forward voltage	$I_{FM} = 0.5A$	—	—	3.0	V
	Reverse current	$V_R = 4V$	—	—	10	μA
	Terminal capacitance	$V = 0, f = 1kHz$	—	30	—	pF
Output	Collector dark current	$V_{CE} = 20V$	—	—	0.1	μA
Transfer characteristics	Current transfer ratio	$I_F = 5mA, V_{CE} = 5V$	50	—	600	%
	Collector-emitter saturation voltage	$I_F = 20mA, I_C = 1mA$	—	0.1	0.2	V
	Isolation resistance	DC500V	5×10^{10}	10^{11}	—	ohm
	Floating capacitance	$V = 0, f = 1MHz$	—	0.6	1.0	pF
	Cut-off frequency	$V_{CC} = 5V, I_C = 2mA, R_L = 100ohm$	—	80	—	kHz
	Response time(Rise)	$V_{CE} = 2V, I_C = 2mA, R_L = 100ohm$	—	4	18	μs
Response time(Fall)	—		3	18	μs	

Classification table of current transfer ratio is shown below.

Model NO.	CTR (%)
A	80 TO 160
B	130 TO 260
C	200 TO 400
D	300 TO 600
E	50 TO 600

Fig.1 Current Transfer Ratio vs. Forward Current

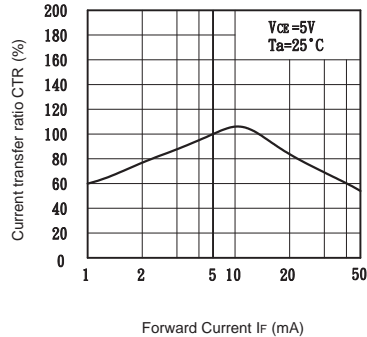

Fig.2 Collector Power Dissipation vs. Ambient Temperature

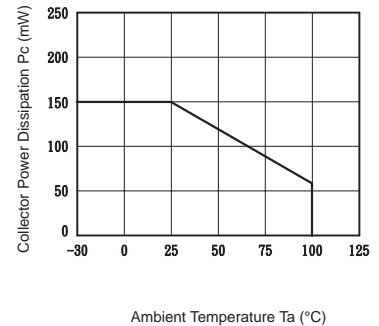

Fig.3 Collector Dark Current vs. Ambient Temperature

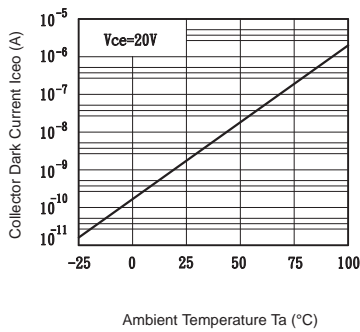

Fig.4 Forward Current vs. Ambient Temperature

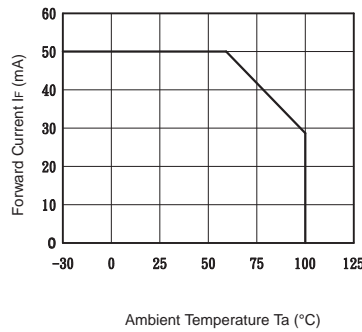

Fig.5 Forward Current vs. Forward Voltage

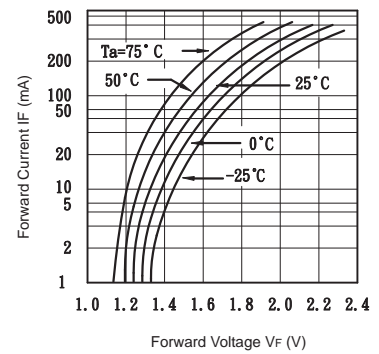

Fig.6 Collector Current vs. Collector-emitter Voltage

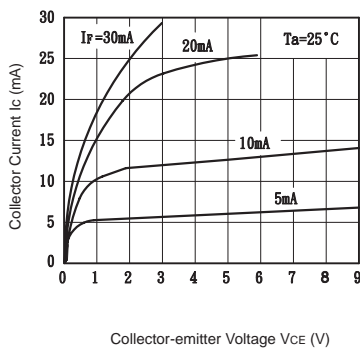

Fig.7 Relative Current Transfer Ratio vs. Ambient Temperature

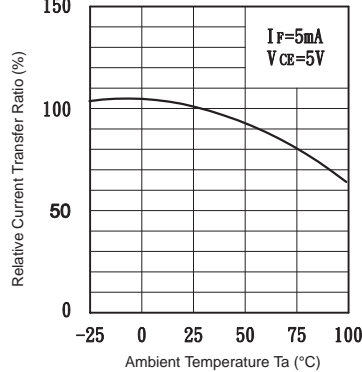

Fig.8 Collector-emitter Saturation Voltage vs. Ambient Temperature

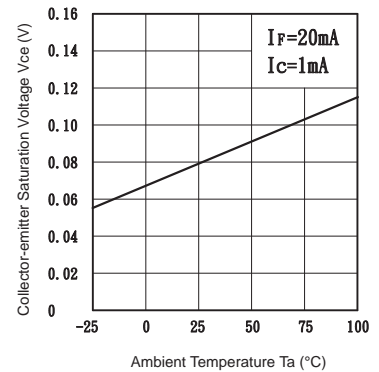

Fig.9 Collector-emitter Saturation Voltage vs. Forward Current

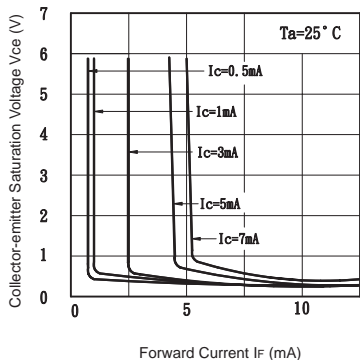

Fig.10 Response Time vs. Load Resistance

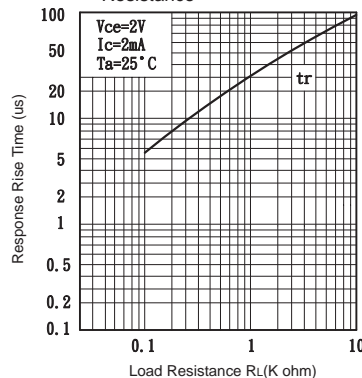

Fig.11 Response Time vs. Load Resistance

